

## soni ROOM DIVIDER | soni DESK PARTITION

- ▶ Our **soni ROOM DIVIDER** and **soni DESK PARTITION** are sound absorbers of a very special kind, because in addition to delivering effective sound-conditioning, they provide increased privacy for your employees.
- ▶ The core of our **soni ROOM DIVIDER** and **soni DESK PARTITION** is a soft non-woven panel, reinforced on both sides by a layer of compacted polyester non-woven. The visible surfaces are covered with dirt-resistant and decorative felt material of high quality. The rounded upper corners of the partition make for a modern, attractive appearance.

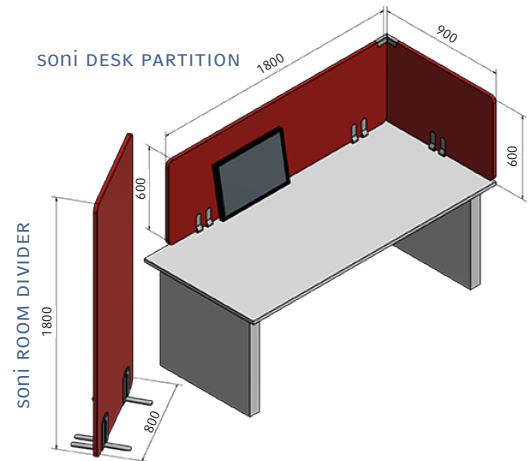

## TECHNICAL DATA

<b>FLAMMABILITY</b>	<ul style="list-style-type: none"> <li>▶ Fulfills the strict fire safety standard for the automotive industry (FMVSS 302, DIN 75 200)</li> <li>▶ ISO 3795, burning rate &lt; 100 mm/min</li> </ul>
<b>TEMPERATURE RESISTANCE</b>	▶ -40°C to +90°C
<b>COLOR FASTNESS TEST OF FELT COVER</b>	▶ DIN EN ISO 105-B02: 6-7
<b>ABRASION RESISTANCE OF FELT SURFACE</b>	▶ ISO 12947-2: > 50.000 rubs
<b>COLOR</b>	<ul style="list-style-type: none"> <li>▶ Orange ▶ Green ▶ Beige ▶ Blue</li> <li>▶ Light grey ▶ Pink ▶ Anthracite ▶ Red</li> </ul>



Directly to the product |  
Color selection

## DIMENSIONS

PRODUCT	THICKNESS / TOLERANCE [mm]	DIMENSION [mm] / WEIGHT	ACCESSORIES
ROOM DIVIDER	25 ± 2	1800 X 800 / 5.5 kg 1800 X 600 / 4.1 kg	soni FIX BASE for room dividers is made of high-quality stainless steel. Weight: 1.5 kg per base. Length x width x height: 350 x 120 x 216 mm
DESK PARTITION	25 ± 2	1800 X 600 / 4.1 kg 1800 X 400 / 2.8 kg 900 X 600 / 2.1 kg	soni FIX CLAMP for desk partitions is made of high-quality stainless steel. Weight: 1.4 kg per table clamp. Height x width x depth: 180 x 120 x 51 mm

## BENEFITS

- ▶ Easy and fast assembly and installation without changes to the building structure
- ▶ Noise protection and privacy screen in one. In addition, the entire surface can be used as a pin board
- ▶ Physiologically safe, completely recyclable

## REVERBERATION ROOM

- ▶ Based on DIN EN ISO 354

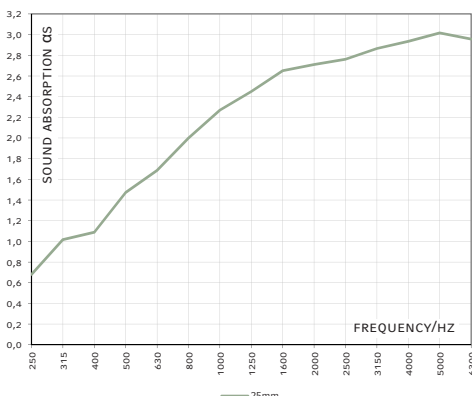

## APPLICATIONS

- ▶ Our **soni ROOM DIVIDER** and **soni DESK PARTITION** score with a very good sound-absorption capacity and can be flexibly deployed wherever you need to reduce the noise level. The easy-to-assemble acoustic partitions blend harmoniously into the office architecture and create pleasant acoustic conditions for concentrated work.



## PLEASE SEE OUR PROCESSING AND STORAGE INSTRUCTIONS

Details and values given in this leaflet are average values and have been compiled with care. They are not binding, however, and Cellofoam International GmbH & Co. KG disclaims any liability for any damages and detriments, also in connection with any third party's rights. The information given does not release the buyers from making the necessary experiments and tests themselves. Subject to technical changes. For updates please go to our website.

Cellofoam International GmbH & Co. KG  
Business unit soniflex  
P: +49 7351 340 28 61  
sales@soniflex.de / www.soniflex.de

## VERSION 04/24

Distribution partner for Switzerland:  
soniflex Switzerland  
P: +41 44 377 60 50  
einkauf@soniflex.ch / www.soniflex.ch

## ASSEMBLY INSTRUCTIONS FOR TABLE CLAMP soni FIX CLAMP

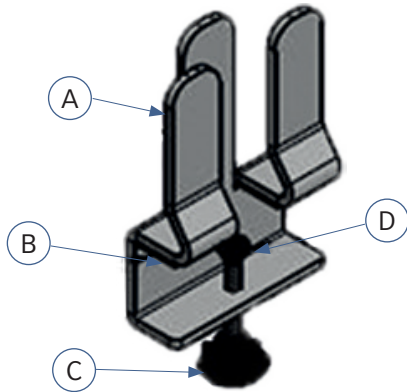

The package contains

- ▶ 1 x soni FIX CLAMP [A]
- ▶ 2 x foam pad [B]
- ▶ 1 x pressure screw [C]
- ▶ 1 x pressure piece [D]

Advice:

- ▶ Suitable for tables up to 45 mm of thickness.

**1.**

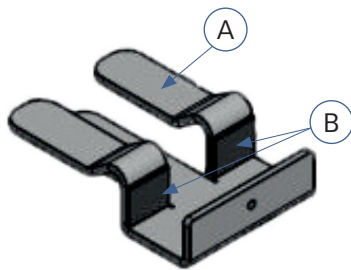

Apply the foam pads [B] to the parts of the soni FIX CLAMP [A] that will rest on the desk/table surface.

**2.**

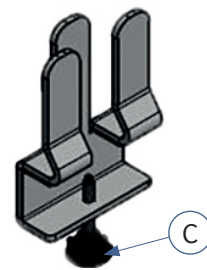

Insert the pressure screw [C] into the thread.

**3.**

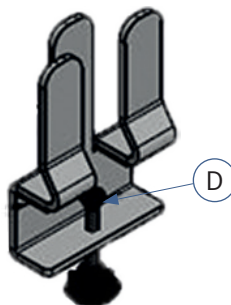

Push the pressure piece [D] onto the ball head of the pressure screw [C] until it engages.

**4.**

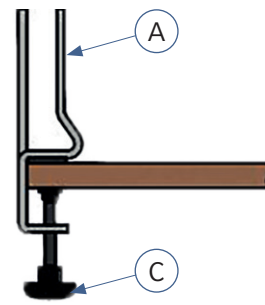

Slide the soni FIX CLAMP [A] onto the edge of the desk/table and tighten the pressure screw [C].

### PLEASE SEE OUR PROCESSING AND STORAGE INSTRUCTIONS

Details and values given in this leaflet are average values and have been compiled with care. They are not binding, however, and Cellofoam International GmbH & Co. KG disclaims any liability for any damages and detriments, also in connection with any third party's rights. The information given does not release the buyers from making the necessary experiments and tests themselves. Subject to technical changes. For updates please go to our website.

**Cellofoam International GmbH & Co. KG**  
 Business unit soniflex  
 P: +49 7351 340 28 61  
 sales@soniflex.de / www.soniflex.de

**Distribution partner for Switzerland:**  
 soniflex Switzerland  
 P: +41 44 377 60 50  
 einkauf@soniflex.ch / www.soniflex.ch